

The product using material and processing must conform to the "WL-PZ-001"HSF technical standard control requirements

RoHS

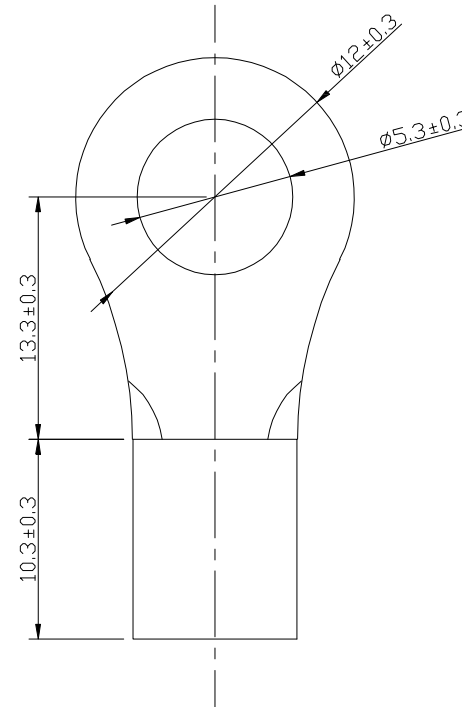
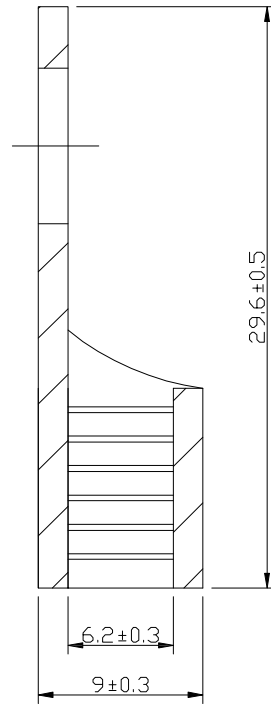

技术要求

- 1、材质：紫铜，厚度1.4mm
- 2、导线截面积：10~16mm²
- 3、最大电流：88A
- 4、表面处理：镀锡

REV.	REVISION RECORD	DATE		GENERAL TOLERANCES		SCALE: 1:1	NAME	DATE	PART.NO:	DWG.NO:	
A0	NEW RELEASE	22.10.28		LINEAR	ANGLES	APPROVED	Wang_jr	22.10.28	RNB14-5	ENDE05	
			UNIT:mm	0.00±0.25	X'±3°	DESIGNER	Han_Gao	22.10.28	TITLE:		WanLian Technology Co., Ltd REV: A0 SHEET: 1/1
			SIZE: A4	0.000±0.10	X'X' ±2°	DRAWN	LanXuan_Hou	22.10.28	0形无绝缘端子 镀锡 RNB14-5		